



Portoncino Ingresso **RD65**

www.ryternaentry.com

RYTERNA

25 anni che produciamo
porte su misura.





RYTERNA Portoncini d'Ingresso

Il portoncino d'ingresso è l'elemento caratterizzante più significativo della tua casa. Ti offriamo un portoncino coibentato da 65 mm di spessore con caratteristiche uniche. I lati interni ed esterni sono realizzati in acciaio inox, l'isolamento interno in poliuretano espanso.

La soglia è realizzata con taglio termico per la massima efficienza energetica. Tutto questo rende il nostro portoncino unico, bello, funzionale, affidabile e resistente all'acqua ed al vento.

Finiture di qualità e di grande effetto in Alunox®, applicazioni in alluminio spazzolato e finestre ed intagli personalizzabili.

Il tutto per rendere il tuo portoncino semplicemente esclusivo.



RD65 Design	7
Versioni disponibili	22
L'esterno della porta	24
L'interno della porta	26
Caratteristiche RD65	28
Finestrature	30







Design **120**
 Colore Esterno **Bianco RAL 9016 opaco**
 Maniglione **H45R 800 mm in acciaio inox**
 Rosetta **ESC-2**
 Finestratura **Vetro laminato**
 Tipo Vetro **Colorato**
 Grado anti-effrazione **RC2**



Design **115**
 Colore Esterno **Grigio RAL 7016 opaco**
 Maniglione **H45R 800 mm in acciaio inox**
 Rosetta **ESC-2**
 Finestratura **Vetro laminato**
 Tipo Vetro **Colorato**
 Grado anti-effrazione **RC2**

Design **110**
Colore Esterno **Old Oak**
Maniglione **H45S 500 mm in acciaio inox**
Rosetta **ESC-1**
Finestratura **Vetro laminato**
Tipo Vetro **Opalino**
Grado anti-effrazione **RC2**



Design **110**
Colore Esterno **Golden Oak**
Maniglione **H45R 500 mm in acciaio inox**
Rosetta **ESC-2**
Finestratura **Vetro laminato**
Tipo Vetro **Opalino**
Grado anti-effrazione **RC2**







Design **109**
 Colore Esterno **Grey RAL7016 matt**
 Maniglione **H45R 800mm stainless steel**
 Rosetta **ESC-2**
 Finestratura **P4A Safety triple glazing**
 Tipo Vetro **Etched effect**
 Grado anti-effrazione **RC2**

Design **109**
 Colore Esterno **Grey RAL7016 anthracite**
 Maniglione **H45R 500mm stainless steel**
 Rosetta **ESC-2**
 Finestratura **P4A Safety triple glazing**
 Tipo Vetro **Etched effect**
 Grado anti-effrazione **RC2**

Design **109**
Colore Esterno **Nero RAL 9005 opaco**
Maniglione **H45R 500 mm in acciaio inox**
Rosetta **ESC-2**
Finestratura **Vetro laminato**
Tipo Vetro **Opalino**
Grado anti-effrazione **RC2**



Design **112**
Colore Esterno **RAL7030 opaco**
Maniglione **H45R 800 mm in acciaio inox**
Rosetta **ESC-1**
Finestratura **Vetro laminato**
Tipo Vetro **Colorato**
Grado anti-effrazione **RC2**













22









100



101



102



103



104



105



106



107



108



109



110



111



112



113



114



115



116



117



118

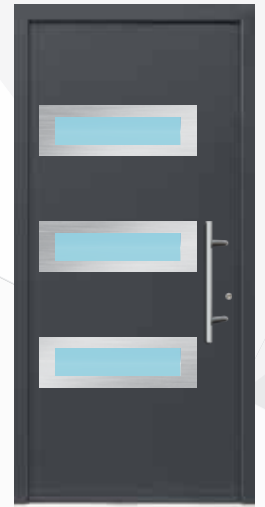

119



120



121



122



123



Individual design

* modificabili secondo il vostro gusto.

UNA PORTA BELLA E PRATICA...

Comandi

Per dare maggiore sicurezza alla vostra porta di casa forniamo varie soluzioni adatte a tutte le esigenze in combinazione o alternative al cilindro esterno.



KP1



KP2



KP3



FSC3



RMT1

Tastiere a codice **KP1 KP2 KP3**

Telecomando **RMT1**

Utilizza il telecomando per aprire tutti gli ingressi della tua casa, anche la tua porta d'ingresso.
Tutta la casa in una sola mano.

Lettores Impronte **FSC3**

Se non vuoi preoccuparti di dove lasci le chiavi utilizza il lettore di impronte, una soluzione d'accesso elegante che può essere integrata direttamente nella porta. La vostra impronta digitale è unica ed è più sicura di qualsiasi tasto.



Maniglioni in acciaio INOX

Disponibili nella versione da 500 o 800 mm



H45R-500
Ø 30 mm
H 500 mm
45°

H45R-800
Ø 30 mm
H 800 mm
45°

H45R-800
Ø 30 mm
H 1200 mm
45°



H45S-500
30x20 mm
H 500 mm
45°

H45S-800
30x20 mm
H 800 mm
45°

H45S-800
30x20 mm
H 1200 mm
45°

Mostrine

A scelta tra la versione tonda o quadra stondata



ESC-1



ESC-2

Cilindro

Oltre al cilindro europeo standard le nostre porte possono essere dotate di un cilindro di sicurezza in classe 6 con profilo personalizzato e servizio di duplicazione protetta. Con possibilità di avere chiave cantiere. Resistenti a tentativi di effrazione o scasso al trapano, al grimaldello, allo spezzamento, ed al bumping.



...UNA PORTA SOLIDA E SICURA

Comandi

Un'ampia gamma di serrature studiata per soddisfare tutte le esigenze. Potrete scegliere quella che più vi aggrada con vari livelli di sicurezza ed efficienza.

3 punti di chiusura **L3P**

5 punti di chiusura **L5P**

Opzione Day& Night **L3P+D&N**

3 punti di chiusura comandati da chiave per la chiusura notturna della porta e scrocco centrale per la gestione diurna della porta.

Electric 1 **L3P+D&N+EM**

3 punti di chiusura comandati da chiave per la chiusura notturna della porta e scrocco centrale per la gestione diurna della porta.

Questa versione può essere associata a tastiere, lettori di impronte e telecomandi (opzionali)

Electric 2 **L5PMA**

5 punti di chiusura. I punzoni e ganci si chiudono a scatto, mentre l'apertura è elettrica.

Questa versione può essere associata a tastiere, lettori di impronte digitali e telecomandi (opzionali)

Electric 3 **L5PA**

5 punti di chiusura. I punzoni e ganci sono comandati da un motore elettrico sia in apertura che in chiusura.

Questa versione può essere associata a tastiere, lettori di impronte digitali e telecomandi (opzionali).

Il massimo della sicurezza possibile

Per le versioni Electric1,2,3 è richiesto un allacciamento elettrico a cura dell'acquirente.
Richiede alimentatore 12V AC o DC 2A





Rostri

Ogni porta è dotata di rostri sul lato incernierato per la massima sicurezza antieffrazione. Nel lato di battuta possono essere scelte serrature a 3 o 5 punti di chiusura.



Guarniture

Le porte sono fornite con guarniture contemporanee di alto livello compatibili con i migliori marchi del settore. Possono essere fornite prive di guarnitura in modo da poterle personalizzare secondo le vostre esigenze.



HLS 08



HLS 09

Cerniere

Ogni portoncino è dotato di cerniere regolabili in tre direzioni per permettere registrazioni semplici e veloci a garanzia di una perfetta chiusura.



Portoncini Ingresso RD65

1. Poliuretano
2. Lamiera in acciaio
3. Zincatura
4. Primer
5. Verniciatura epossidica

Trasmittanza termica fino a:
0.73 W/m²K

Specifiche Tecniche

Telaio in alluminio composito da 65 mm di spessore con taglio termico da 24 mm di spessore.

Disponibile nella versione cieca con lastre in alluminio e riempimento in poliuretano espanso da 65 mm.

Isolante interno esente da CFC.

Guarnizioni

Per garantire un perfetto isolamento il portoncino è dotato di tre guarnizioni continue di tenuta:

1 sul telaio e 2 sull'anta.

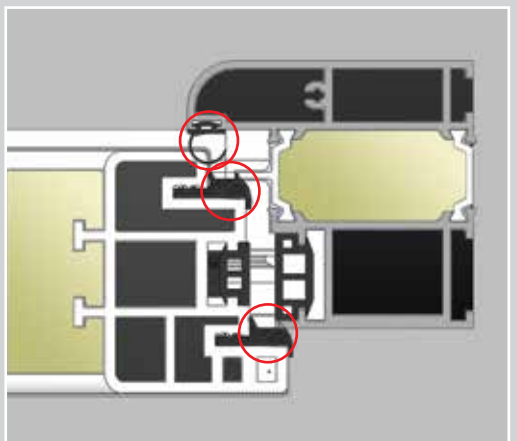
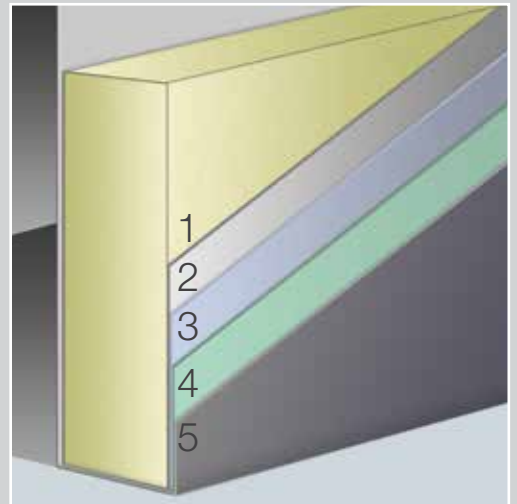



Soglia

Soglia calpestabile in alluminio e PVC composito a lunga durata.

Dimensioni

Altezza interna della soglia di 12 mm e di 22.5 mm sul lato esterno.

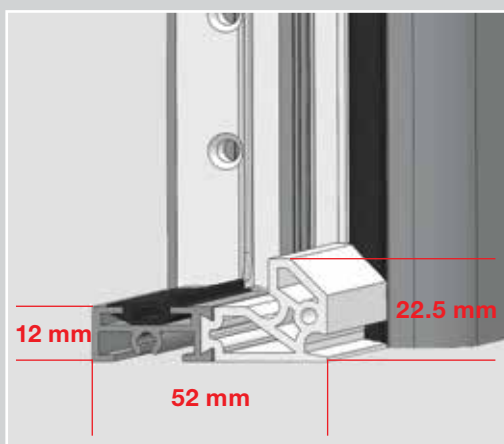

Profili Aggiuntivi

Profili aggiuntivi inferiori da 15mm e 30mm abbinabili tra loro.
(es. 15mm+30mm+30mm...)

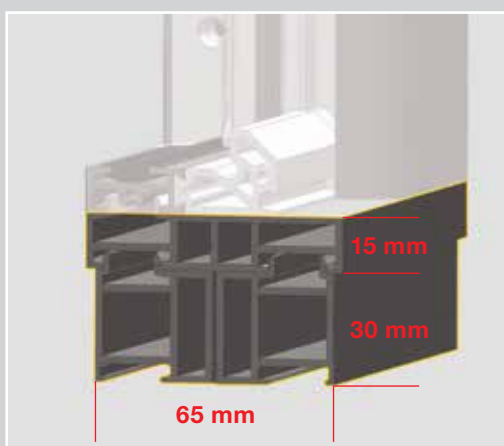

Colori

Esternamente i colori RAL disponibili sono il 7016 ed il 9016, è possibile inoltre la versione SIMIL LEGNO e la verniciatura a richiesta da tabella RAL. Per il lato interno è prevista la colorazione RAL 9016.



*Golden Oak



*Old Oak



RAL
Colour



✓ **Sopraluce e finestre laterali**

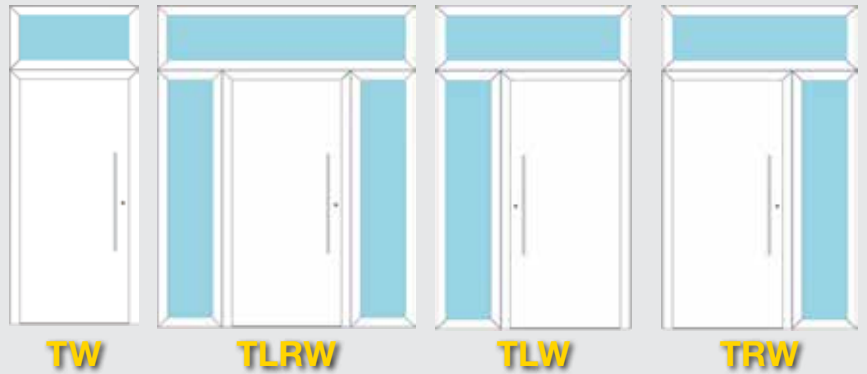
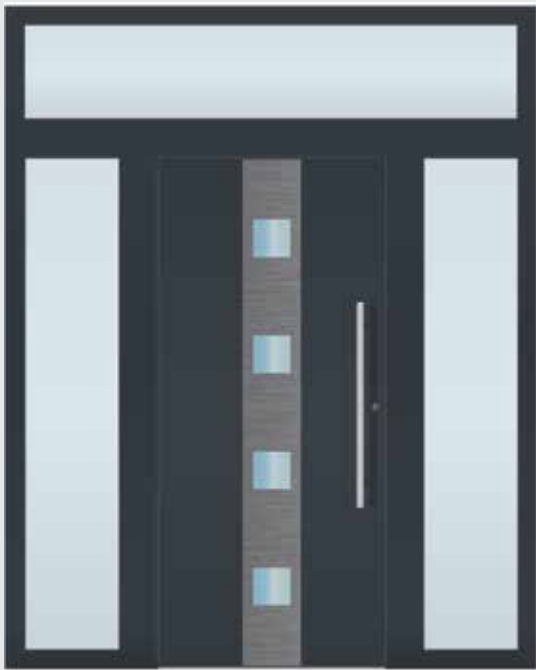

✓ **Vetri Disponibili**

STANDARD

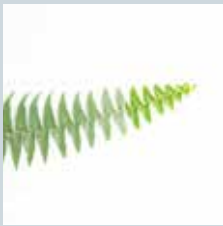

Trasparente **SGC**



Opaco **SGM**

NON-STANDARD



Similar Delta Nr. 121



Chinchilla



Kathedral Klein



Similar Silvit Nr. 118

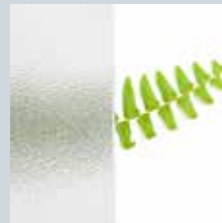

Crepi



Colorato **SGT**

✓ **Vetri Incisi**

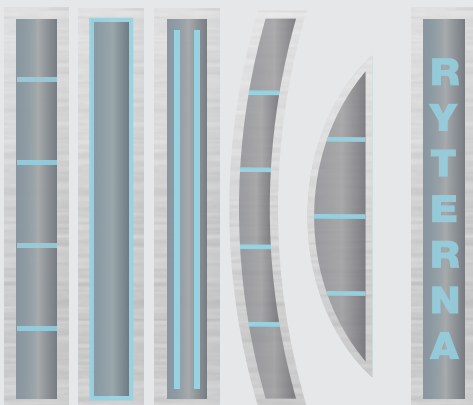

Consultare la produzione per esecuzioni personalizzate.



