

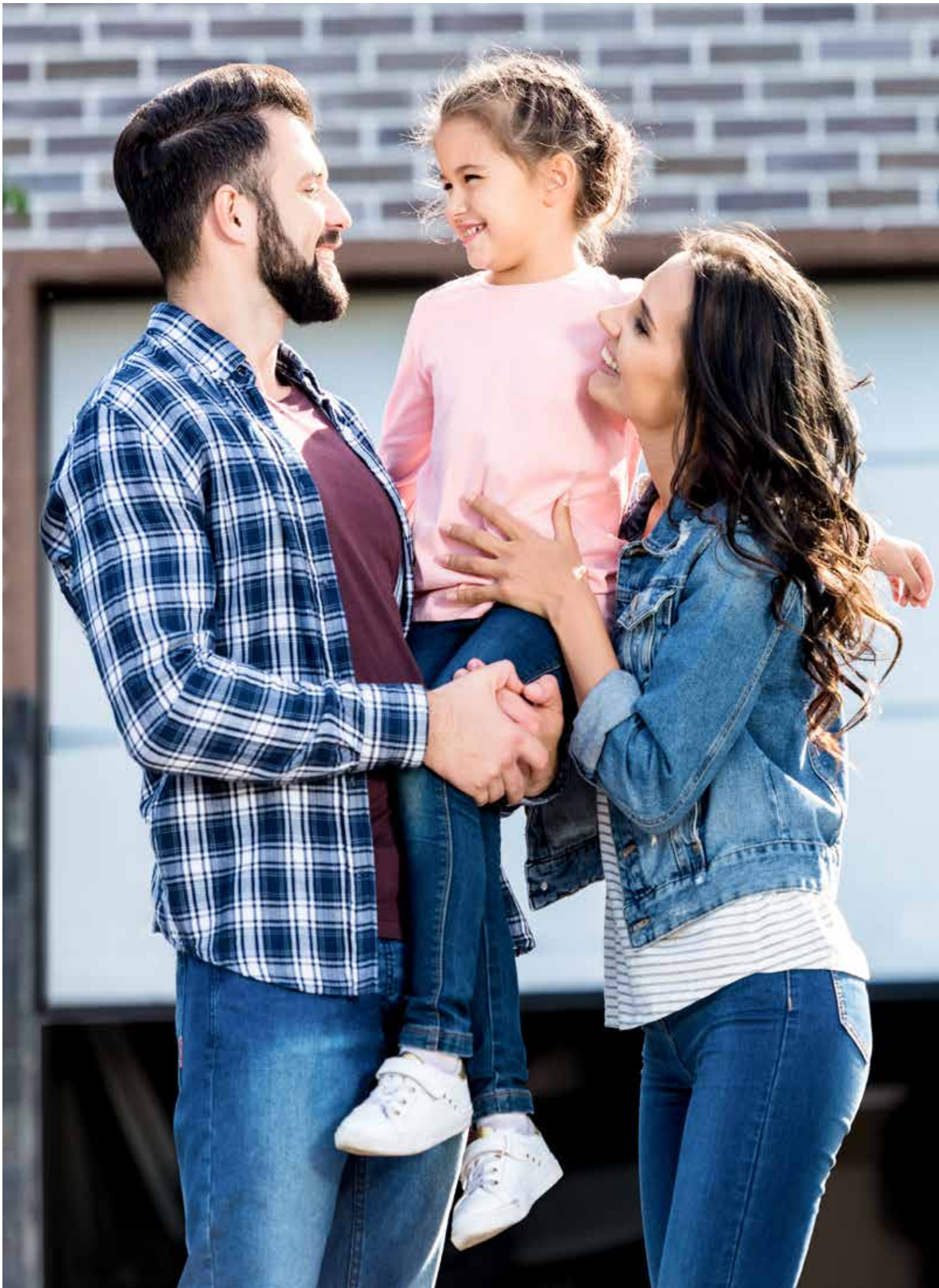

# GARAAŽIUKSED

by **RYTERNA**





# Sisukord:

6	RIB
8	MIDRIB
12	FLUSH
14	GEORGIAN (CASSETTE)
16	SLICK
20	SLICK PLUS
22	MACRORIB & MICRORIB
24	TOPRIB
26	SLIM LINE
28	OKOUME
30	ALUMAX
32	RETRO
34	TIIBUKSED
40	KÜLGUKSED
44	KÄIGUUKS
46	DEKORATIIVSED APLIKATSIOONID
48	FULLVISION TÄISAKNA LAHENDUSEGA PANEELID
49	ROOSTEVABAST TERASEST AKNAD
49	PVC DOUBLE GLAZED WINDOWS
51	TÕMBVEDRUDEGA SIINID R40
53	RIISTVARA SIINITÜÜBID TORSIOONVEDRUDEGA
54	PANEELID JA RAAMID
55	LISATARVIKUD
56	SEKTSIOON LIUGUKS
60	ERITELLIMUSEL VALMISTATUD UKSED
62	MITTE-STANDARDSED LAHENDUSED
62	SOBIV DISAIN





Sektsioonuks TL Alumax.  
Välisuks RD80 eritellimus



# Piiramatu loovus

Mõttele kastist välja



# Rib



Rib uksepaneelil on 10cm vahedega horisontaalsed jooned, mis annavad uksele kaasaegse välimuse. Rib paneel sobitub väga hästi mistahes arhitektuurilisse keskkonda. Rib disainiga uksi kombineeritakse sageli ka full-vision alumiiniumpaneelidega, mille profiilid saab värvida kogu RAL kataloogis antud värvitoonide ulatuses. Wood Rib stiilis ukсед on puidusüü reljeefse pinnaga. Rib paneelid sobivad ideaalselt suurte uste valmistamiseks - laiusega kuni 10m.



RAL kataloog



Puidusüü



Krohv



RAL 9016



RAL 8017

Siini tüüp R40 UM/ SM/ TM, TL STD/ LHR FM/ LHR RM



# Midrib



Midrib uksepaneelil on reeglina 25cm vahedega horisontaalsed jooned. Midrib disainused jätvavad eheda täispuitlaudise mulje, mistõttu on see väga populaarne disain kogu Euroopas. Midrib paneelid on saadaval puidusüü, krohvi ja siledade pindadega. Midrib paneelidel on lai standardtoonide valik, lisaks on kõiki uksti võimalik tellida RAL kataloogis antud värvitoonide ulatuses. Midrib Smooth disainused on sileda pinna ja naturaalse puidu välimusega. Paneelid on UV-kindlad. Saadaval on nii Hele tamm, Kuldne tamm, Vana tamm, Mahagon kui ka Winchester viimistlustega paneelid.



RAL kataloog



Sile



Puidusüü  
muster



Krohvi



RAL 9016





Hele tamm  
hele



Kuldne  
tamm sile



Vana tamm  
sile



Tume tamm  
sile

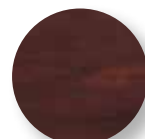

Mahagon  
sile



Winchester  
sile

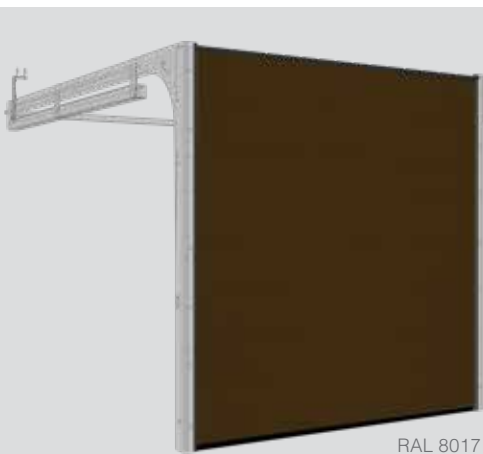

RAL 8017

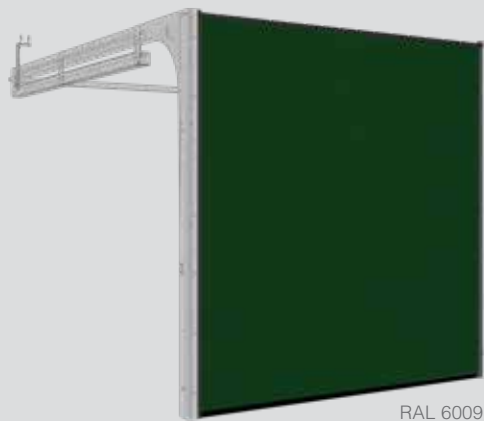

RAL 6009

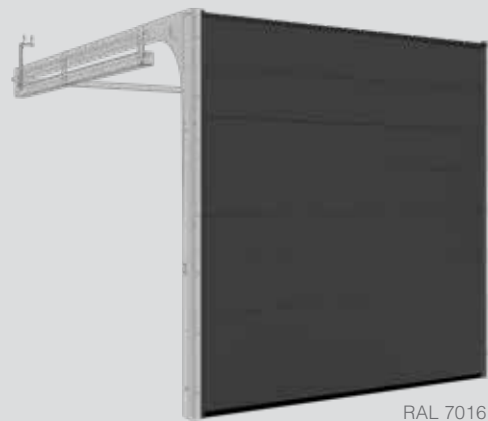

RAL 7016

Siini tüüp R40 UM/ SM/ TM, TL STD/ LHR FM/ LHR RM



Seksioonuksed: TL Midrib Old Oak.





# Flush



Flush paneelid on joonteta, mis on saadaval sileda, puidusüü või krohvi pinnastruktuuriga. Flush paneelidest valmistatud uksed sobivad ideaalselt nii miljööväärtuslikele kui ka kaasaegsetele majadele. Flush paneelide välimus on peen ja elegantne, eriti kombineerituna roostevaba terasest akendega. Flush paneelidel on lai standardtoonide valik, lisaks on kõiki uksi võimalik tellida RAL kataloogis antud värvitoonide ulatuses.



RAL kataloog



Puidusüü



Krohv



RAL 9016

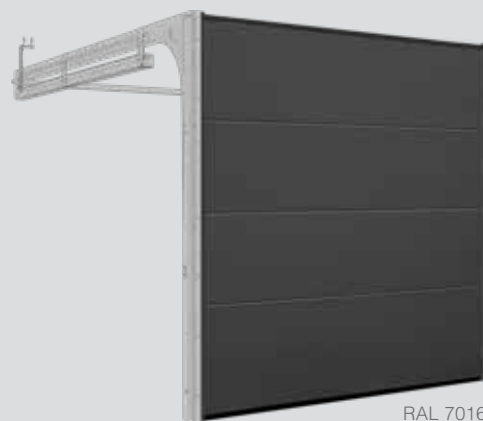

RAL 7016

Siini tüüp R40 UM/ SM/ TM, TL STD/ LHR FM/ LHR RM



## Georgian (Cassette)



Georgian tüüpi uksed valmistatakse stiilsetest ristkülikukujulistest taheldusega paneelidest. 'Georgian' disain sobib suurepäraselt pärand- ja maalähedases stiilis majadega.



RAL kataloog



RAL 9016  
puidusüü muster



Kuldne tamm  
puidusüü



RAL 9016



Golden Oak

Siini tüüp R40 SM/ UM/ TM, LHR FM/ TL STD/ LHR RM



# Slick



Tippklassi 'Slick' disainuks pakub siledat paneelipinda. See sobib suurepäraselt roostevabast terasest akende või aplikatsioonidega kombineerimiseks. Metalne või pärliefektiga viimistlus muudab teie ukse lihtsalt vastupandamatuks.



RAL 9016



RAL kataloog



RAL pärlivärvid



Sile





RAL 9006

RAL 7016

RAL 9004

Siini tüüp R40 SM/ UM/ TM, LHR FM/ TL STD/ LHR RM



Sektsioonuksed: TL Slick RAL 7016.  
Välisüks RD80 disain 303





# Slick Plus - Eksklusiivsed katted



Roostevaba teras



Metalne anarhiit hall



Vask

Eksklusiivselt lamineeritud.

Sileda pinnaga uksed, mis on viimistletud muljetavaldavas Stainless Steel, Anthracite Grey Metallic, Copper, 3D Grey, 3D White, Linea toonis.



Siini tüüp R40 SM/ UM/ TM, LHR FM/ TL STD/ LHR RM



## Macrorib & Microrib



Macrorib paneelist valmistatud uksed on krohvitud pinnastruktuuri ning 20mm reljeefse lainetusega. Atraktiivsed ja modernse välimusega uksed sobivad nii elu - kui ka ärihoonetele. Macrorib uksed on saadaval standardses RAL 9016 valges toonis. Võimalik on tellida ka kõiki teisi värvitoone RAL kataloogi alusel.

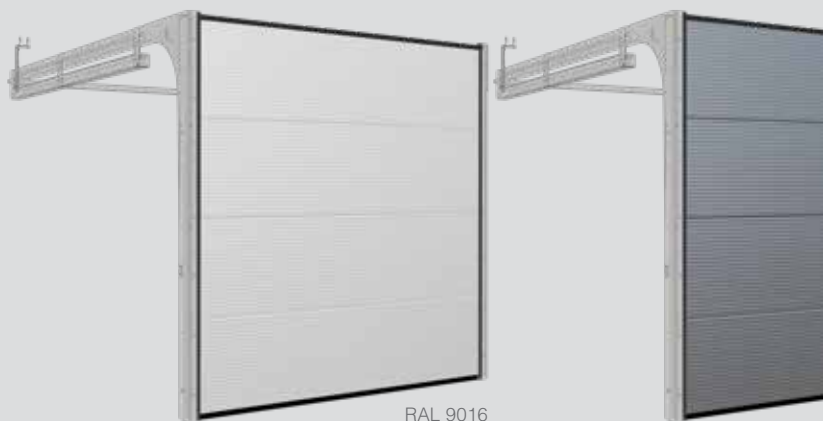

RAL 9016



RAL kataloog



Krohv 20 mm  
laineline pind



RAL 9016

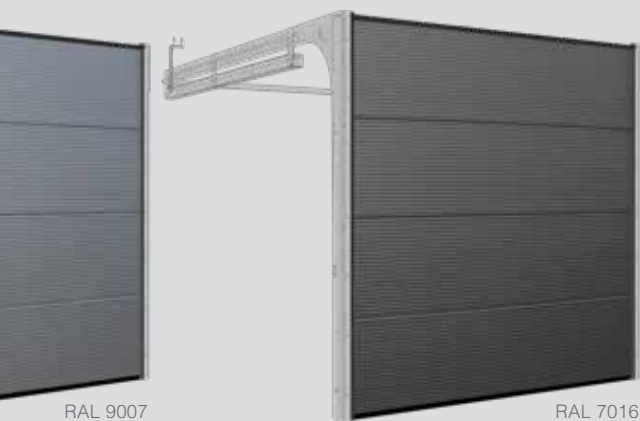

RAL 9007

RAL 7016

Siini tüüp R40 SM/ UM/TM, LHR FM/ TL STD/ LHR RM

Selle kaasaegse disainiga ukse tugevus seisneb selle erakordselt siledas pinnas, mis iga 10 mm järel kergelt lainetab. Neid ainulaadseid paneele saab kombineerida roostevabast terasest akendega, et luua loominguline ja praktiline välimus. 'Microrib' ukсед on standardses RAL 9016 valges toonis või värvitud mistahes RAL värvitoonis. Microribi ukse metalne viimistlus loob vapustava efekti.



Sile  
10 mm laineline  
pind



# TopRib - Tagasihoidlik elegants



Topeltsoonega disain on üks silmapaistvamaid kujundusi turul. Kolm uksetasapinda eraldavat topeltjoont muudavad selle ukse sarnaste toodete seas silmapaistvaks.



RAL kataloog



RAL pärlivärvid



Sile



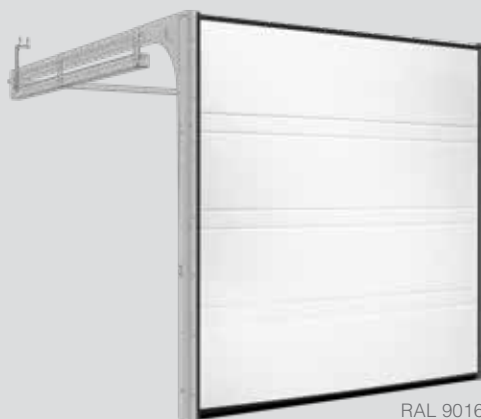
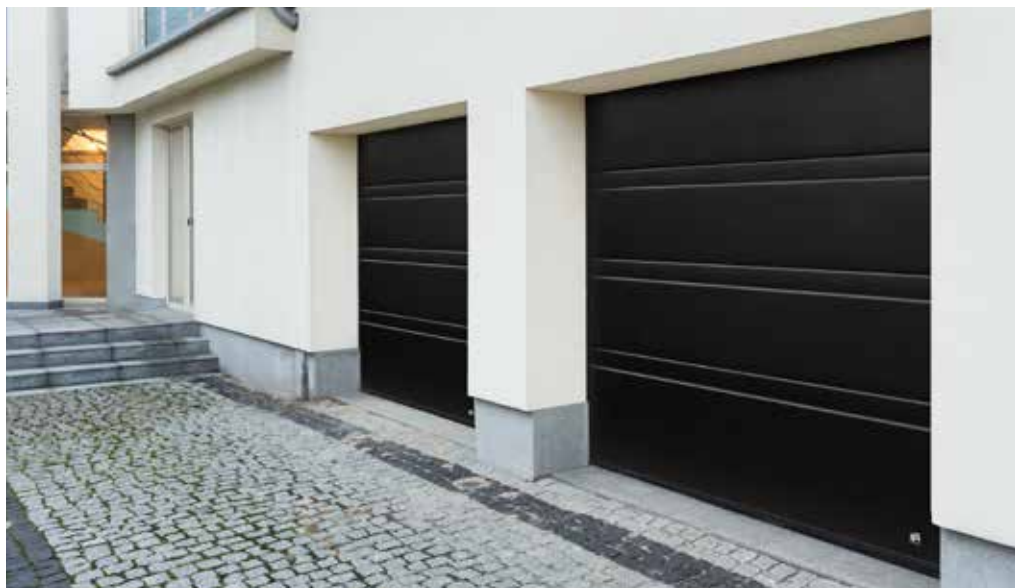

RAL 9016



RAL 7016

Siini tüüp R40 SM/ UM/ TM, LHR FM/ TL STD/ LHR RM



## Slim Line

Slick-paneelide ja kitsaste klaasitud alumiinium-profilide kombinatsioon annab sellele uksele väga erilise välimuse. Nimetame seda uksekujundust 'Slim Lineks'. Saadaval on erinevat tüüpi klaasid. Akna kõrgus võib varieeruda 5 kuni 10 cm. LED-ribaga klaasimine muudab ukse kauniks nii päeval kui öösel. Klaasi katkematu maksimaalne laius on kuni 3 meetrit.







## Okoume - Looge oma isiklik stiil

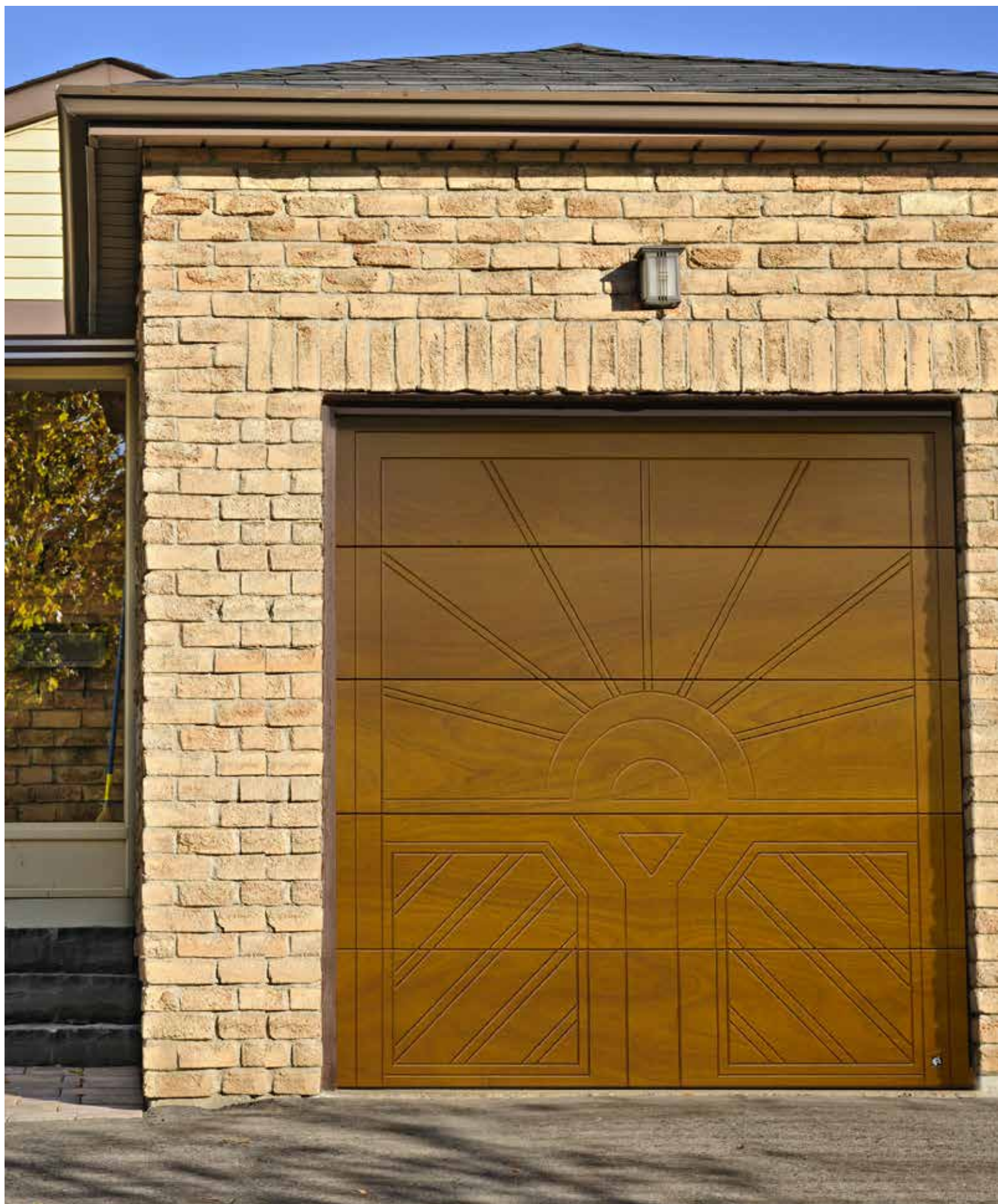



Standardsed uksepaneelid, mis on plakeeritud 12 või 18 mm paksuse okoume merevineeriga. Laevaehituses kasutatakse ülimalt veekindlat okoume lehtpuitu. Okoume kihiti nikerdades või freesides saame taasluua erinevaid motiive, mustreid ja ornamente. Seda võib lakkida erinevates toonides või värvida peaaegu kõigis värvitoonides. Kombinatsioon erikujuliste akende ja spetsiifilise disainiga annab suurepärase võimaluse paigaldada meie uksi ka kõige kõrgemate arhitektuuriliste nõuetega hoonetele. Kaks kihti krunti ja kolm kihti lakki või värvi annavad pikaajalise kaitse elementide eest. Saadaval igat tüüpi garaažiustele.





## Alumax - Piiramatult ruumi loovusele



Sektsioongaraažiuks Alumax erikujundusega RAL.  
Välisüks RD80 kohandatud disain.



Tipptasemel tehnoloogia garaažiuste disainis.  
Piiramatult ruumi loovusele!

Idealselt sobivad välisuste ja garaažiuste kujundused. Sektsioonukse paneelid on plakeeritud 2,5 mm alumiiniumlehtedega, mis on freesitud ja värvitud mistahes RAL kataloogis antud värvitooni, sealhulgas metall-viimistlusega ning kaunistatud inkrustatsiooniga, võivad luua tõelise kunstiteose.





## Retro - Pärandiga sobitamine

Retro välimusega ukсед on valmistatud vanaaegset ehitusstiili järgides. Soonilised, puidusüü plankudega kaunistatud osad. Varustatud vanaaegsete metallist hingede ja käepidemetega. Soovi korral on saada val kohandatud disain.



Retro S



Retro X



Retro H









# Tiibuksed



Tiibuste maksimaalsed mõõdud on: laius 3m x kõrgus 2,5m. Tiibustel on lai värvitoonide ja paneelimudelite valik. Tiibuksel on võimalik valida erikujulisi ja erinevate suurustega aknaid, klaasitud paneeli, roostevabaterasest aplikatsioone ning isegi lemmikloomade käiguust. Käepideme standardvärvid: must, valge, alumiinium. Lisavõimalusena saab käepideme viimistleda uksega sama värvi..



RAL kataloog



Sile



Puidusüü



Krohv







Espagnolette lukk - teeb teise riivi avamise ja sulgemise lihtsaks.

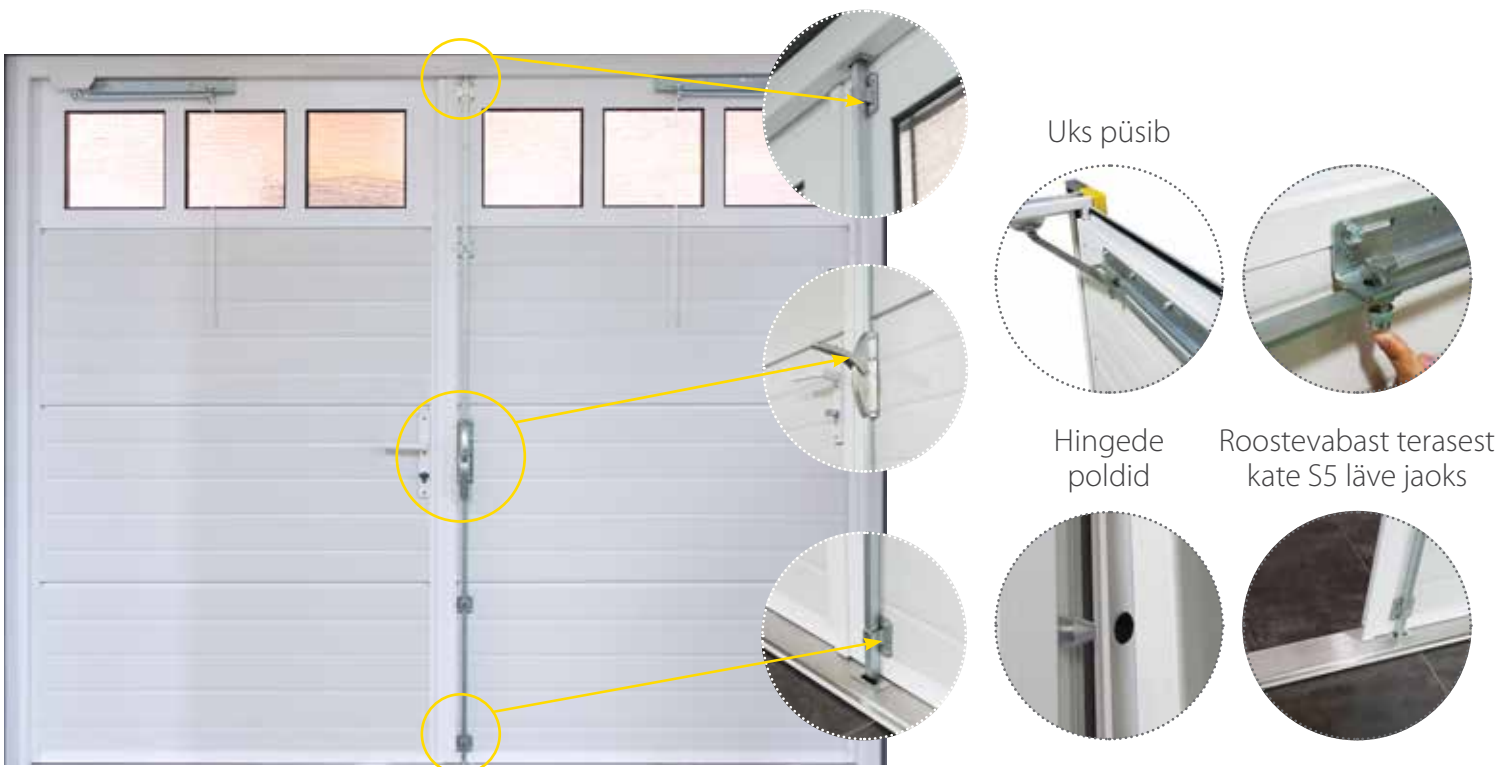

# Vanaaegse stiili moderne puudutus

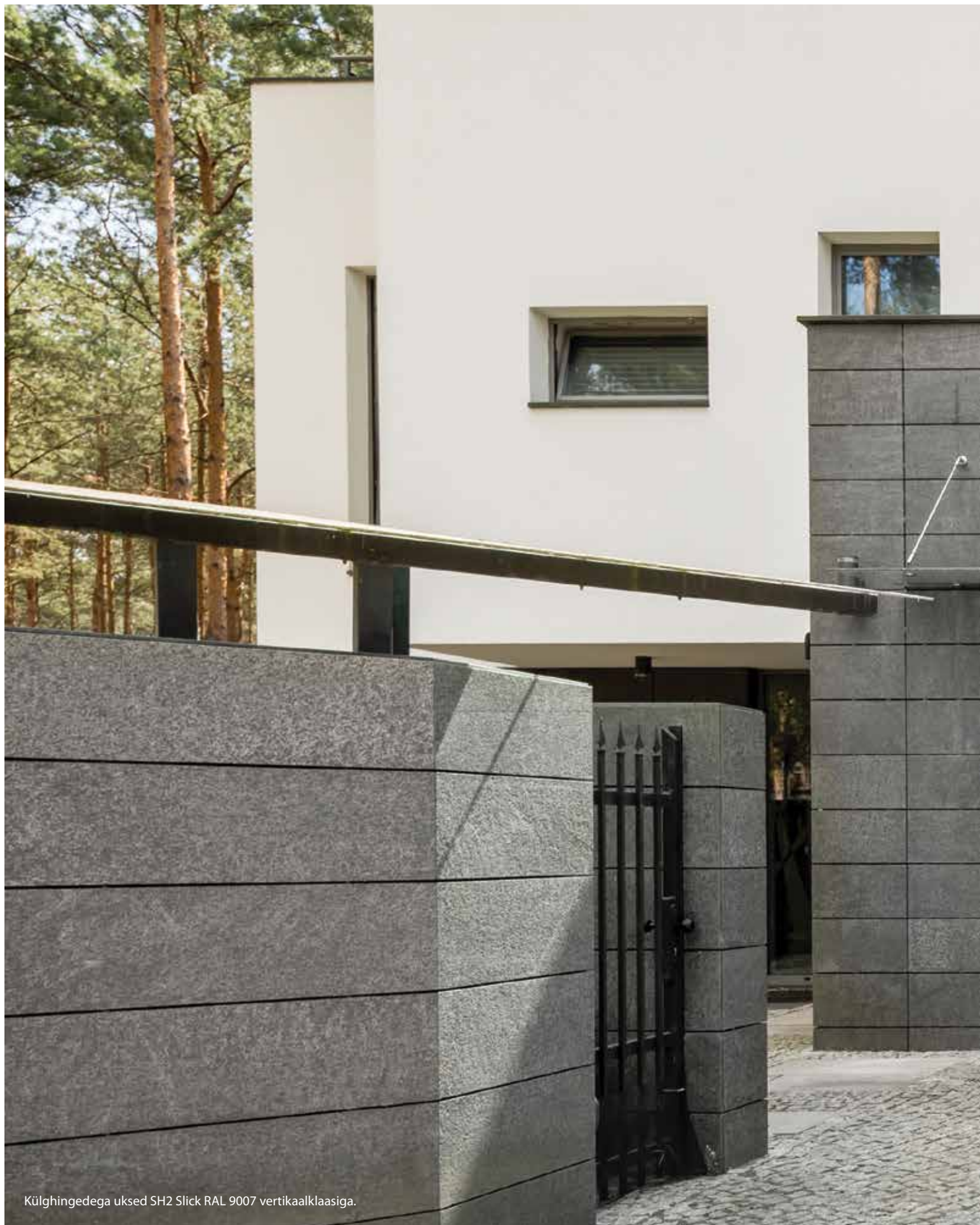

Külghingedega uksed SH2 Slick RAL 9007 vertikaalklaasiga.





## Käiguuksed



Ryterna eritellimusel garaažiukse disainiga sobituvad käiguuksed. Soojustatud Ryterna käiguuksed on valmistatud isoleeritud 40 mm paksustest paneelidest tervet perimeetrit katva kummitihendiga. Ühtne disain ja paigutus loovad maja fassaadi ühtsuse.





Standardraam



Lüstudega raam



Lihtne külgsentele kinnitada

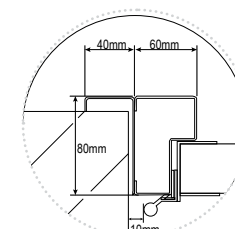

Raami mõõdud



Käepideme standardvärvid:  
alumiinium, must, valge.  
Muud värvid soovi korral.



Hingede poldid







# Käiguuks



Käiguuks on mugav valik, kui garaaži kasutatakse muuks otstarbeks, kui autode hoidmiseks. Käiguukse maksimaalne laius on 1,2m. Võimalik on tellida nii parema - kui ka vasakukäelisi uksi, madala lävepakuga.



Madala lävepakuga läbipääsu uks



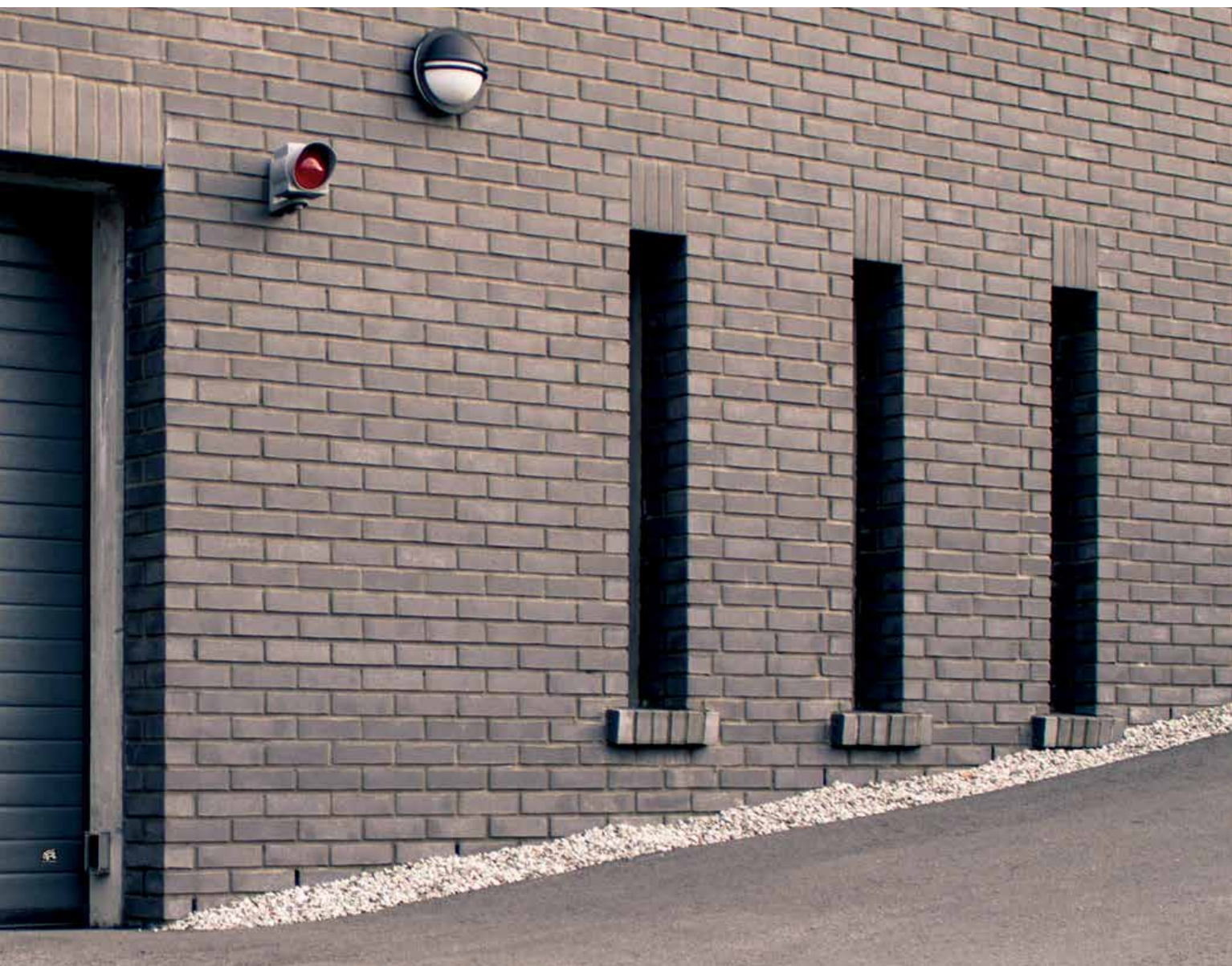



## Dekoratiivsed aplikatsioonid

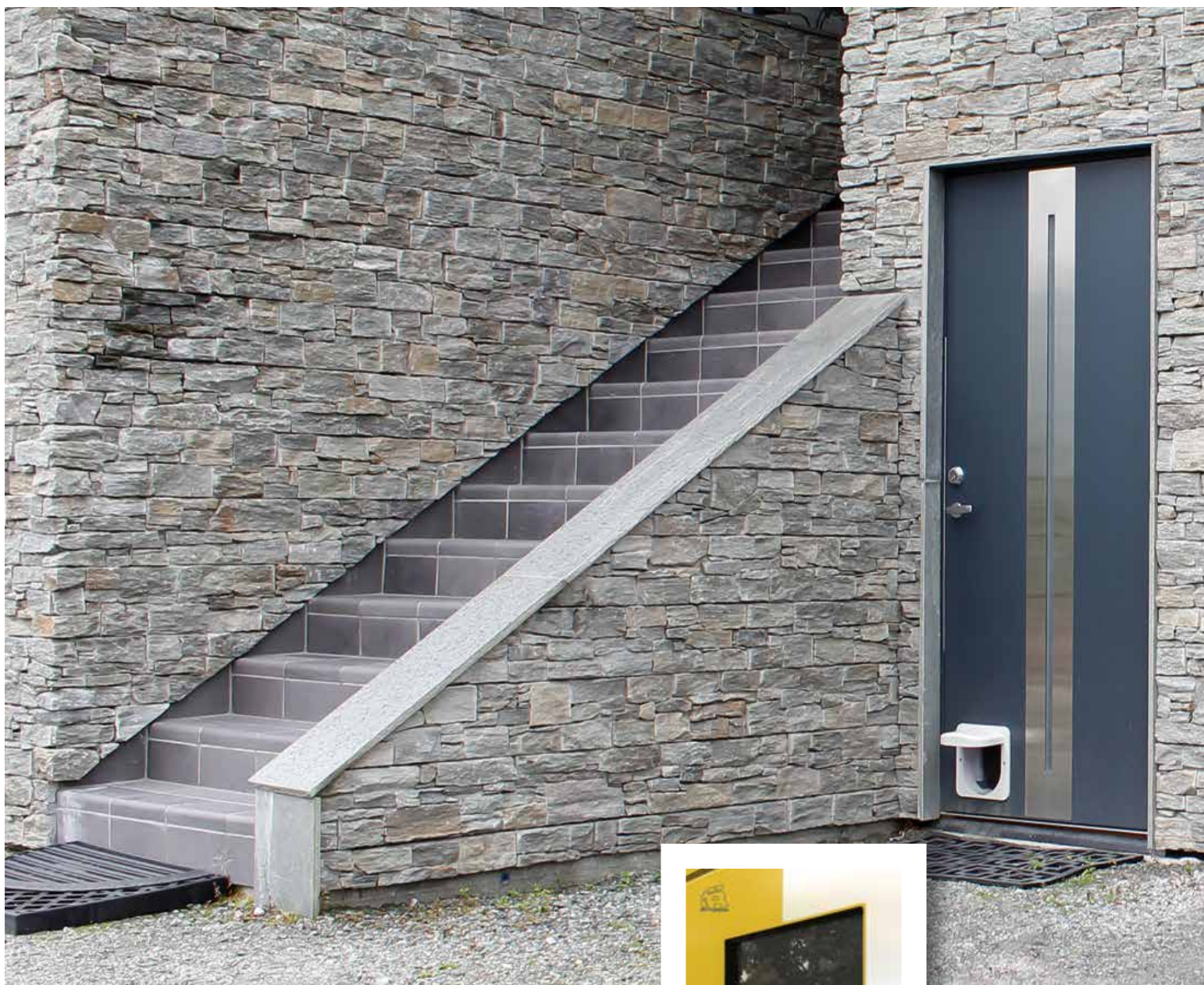

Pakume laias valikus roostevabast metallist aplikatsioone. Harjatud metalliefektiga või värvitud mistahes RAL kataloogis antud värvitooni. Aplikatsioonid sobivad ka kõige nõudlikumate disaininõuetega. Kui te ei leia seda, mis teile meeldib, võime valmistada ka teie isikliku kujundusliku aplikatsiooni. Saatke lihtsalt pilt või joonis ja me kopeerime selle teie uksele.



Rohkem valikuid leiate  
DESIGN kataloogist



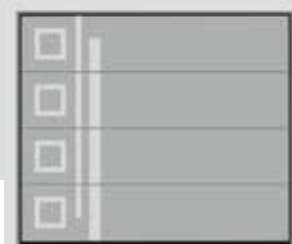
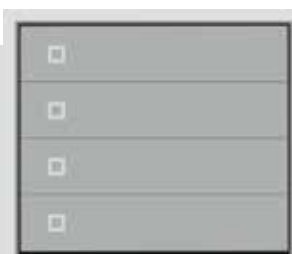
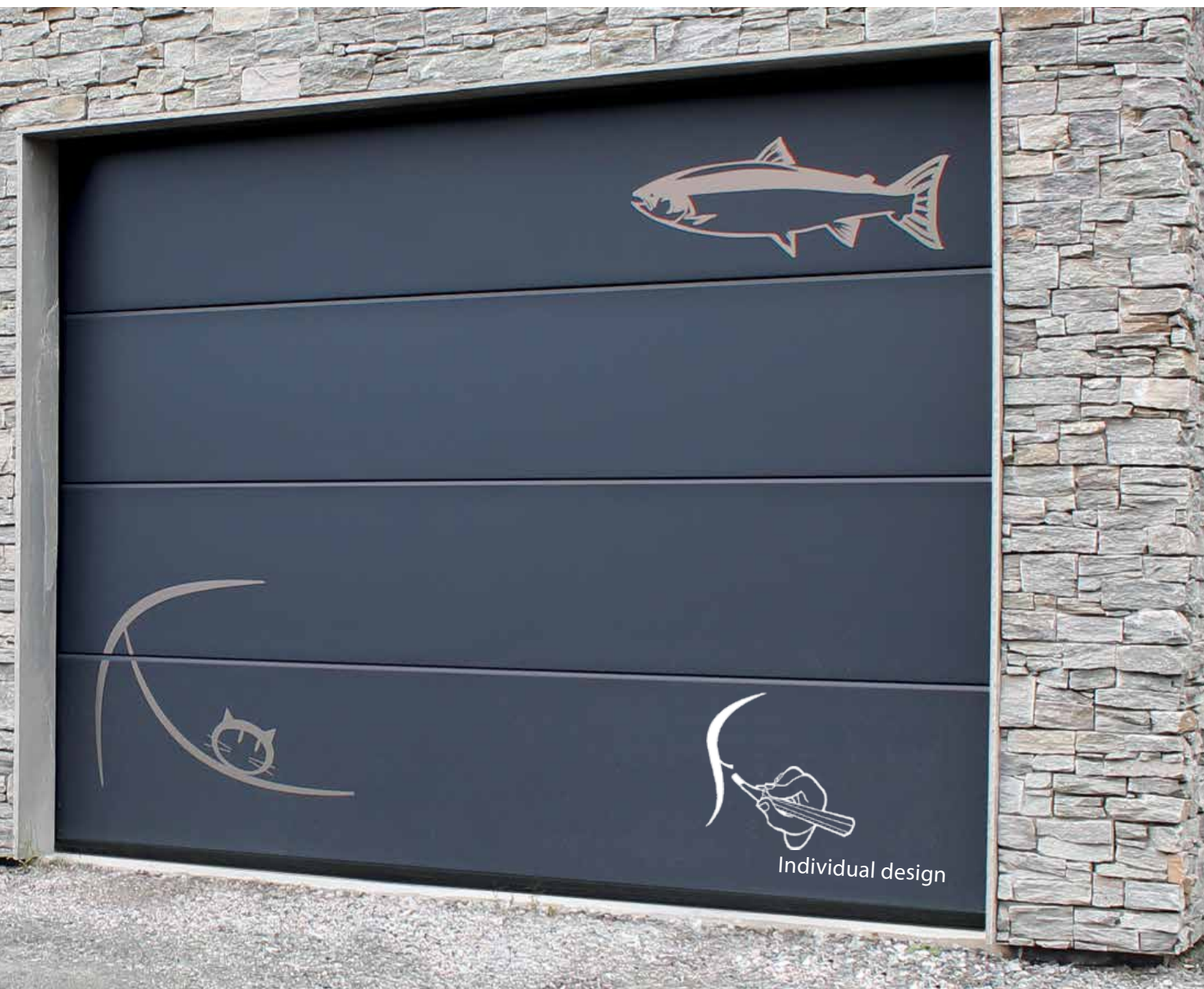



# Fullvision täisakna lahendusega paneelid

Fullvision täisakna lahendusega paneelid saab katta mistahes RAL kataloogis antud värvitooni või Golden Oak viimistlusega. Akrüülist topeltklaasid on läbipaistva, mati, 'härmas'- või toonitud viimistlusega ja perforeeritud terasest.

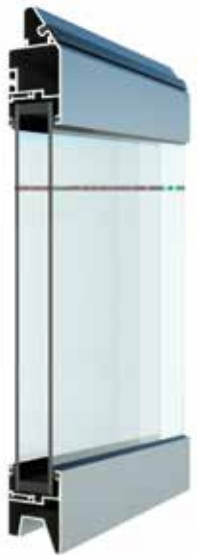

selge

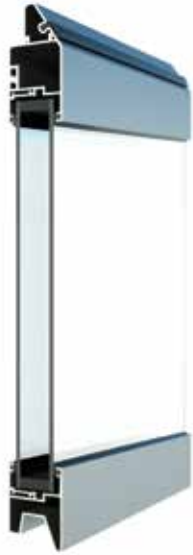

matt



'härmas'



toonitud



perforeeritud teras





# Roostevabast terasest aknad

Roostevabast terasest akende kasutamine annab teie garaažiuksele kaasaegse ja ainulaadse välimuse. Kasutage meie soovitatud kujundusi või looge ise oma kujundus.



MAXI 315 x 315 mm

MIDI 235 x 235 mm

MINI 155 x 155 mm



MAXI 315 mm

MIDI 235 mm

MINI 155 mm

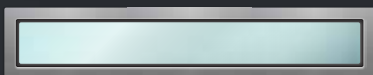

805 x 155 mm



## Topeltklaasiga PVC aken

Pakume mitmesuguseid aknaid ja dekoratiivelemente, mis muudavad iga kodu eriliseks. Akrüülist aknaraame ja ääriseid saab värvida, et need sobiksid teie ukse või teie maja olemasolevate värvidega.





1



Ohutu ja töökindel siinisüsteem. Siinid on standardset tsiingitud, kuid neid saab ka pulbervärvida peaaegu igas värvitoonis.

2

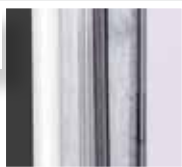

Kogu perimeetri ulatuses olev kummitihend muudab ukse energiasäästlikuks.

3



4



5



6



7



# Riistvara tüüp R40

R40 sektsioonuksed on kliendi- ja paigaldajasõbralikud. Need nõuavad minimaalset pea- ja küljeruumi ning on ideaalne valik nii uusehitistele kui ka renoveeritavatele majadele.

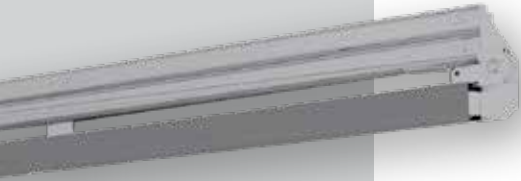

Pingutusvedru süsteemi saab paigaldada nii küljele, peakohale kui ka siinide alla. 4-vedru süsteem tagab ohutu ja usaldusväärse töökindluse.

Kuullaagriga rullid. Nailonkatttega rullid tagavad pikema eluea ja vaikse töö.

Sõrmekaitse. Muljumisvastased paneelid tagavad ohutu töö.

Reguleeritava rullkanduriga külgmised hinged tagavad tõhusaima jõudluse.

Mugav sisemine käepide asub allnurgas ja on manuaalse juhtimise korral väga kasulik.



**R40-TM**



**R40-SM**

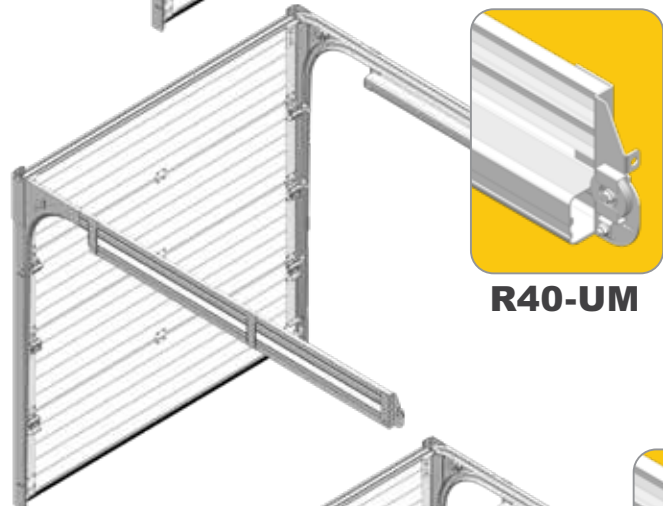

**R40-UM**

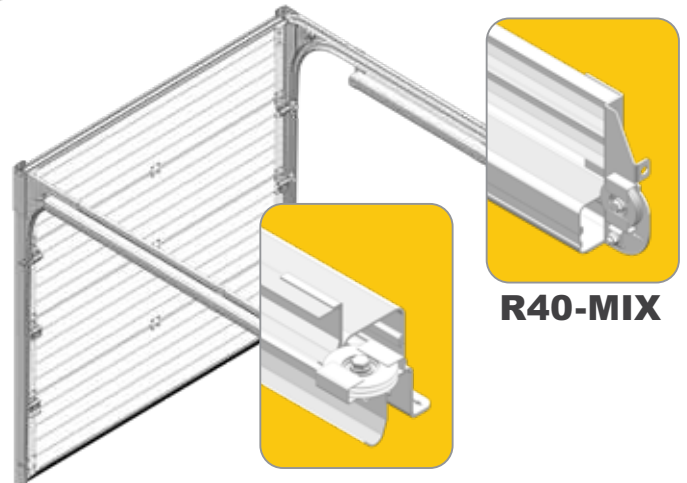

**R40-MIX**



1

Ohutu ja töökindel siinisüsteem. Tööstusliku kvaliteediga siinid on loodud töökindlaks ja turvaliseks tööks.

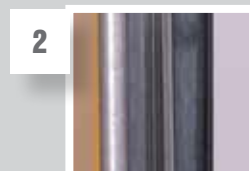

2

Kogu perimeetri ulatuses olev kummitihend muudab ukse energiasäästlikuks.

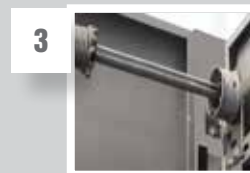

3



4



5

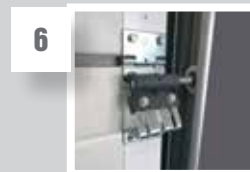

6



7

# Riistvara tüüp TL

Meie garaži seksioonuste komponendid on välja töötatud ja testitud kõige nõudlikumates tööstustingimustes. Aastakümnete pikkuse tegevuse jooksul oleme täiustanud oma uste kõiki detaile. Nimetame seda intelligentseks kvaliteedikontrolliks ja see on pidev protsess.



Torsioonvedrusüsteem võimaldab ehitada kuni 12 meetri laiust sujuvat ja töökindlat ust.

Kuullaagriga rullid. Nailonkattega rullid tagavad pikema tööea ja vaikse töö.

Sõrmekaitse. Muljumisvastased paneelid tagavad ohutu töö.

Reguleeritava rullkanduriga külgmised hinged tagavad suurima jõudluse.

Mugav sisemine käepide asub allnurgas ja on manuaalse juhtimise korral väga kasulik.

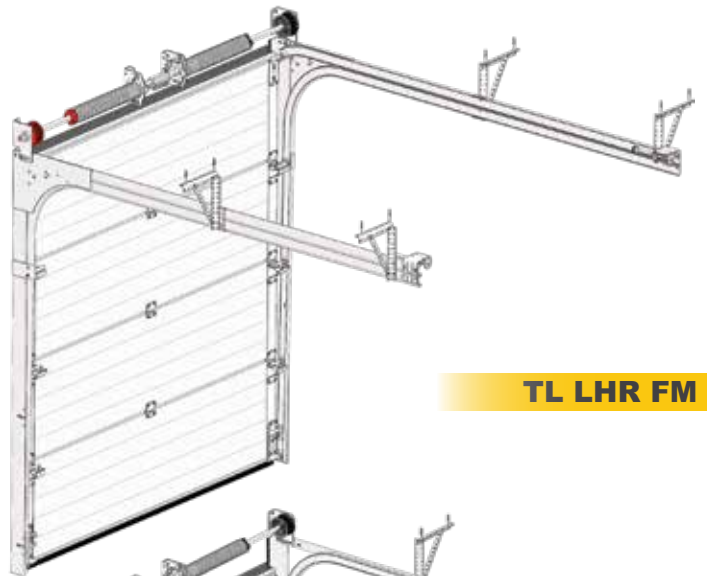

**TL LHR FM**

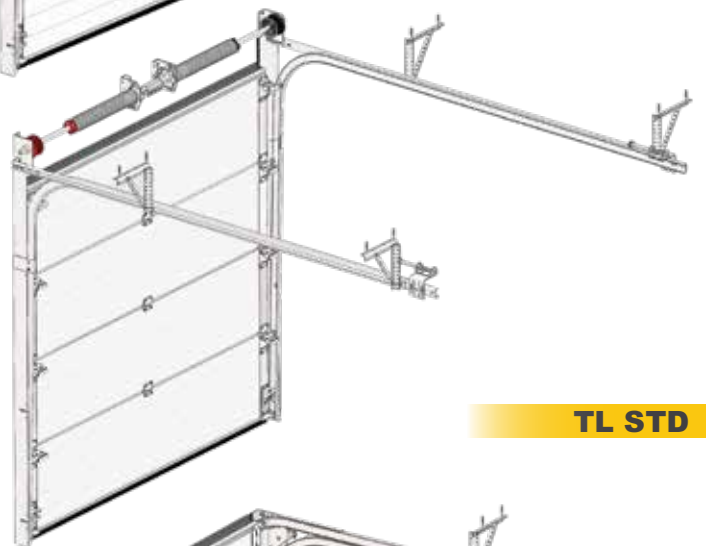

**TL STD**

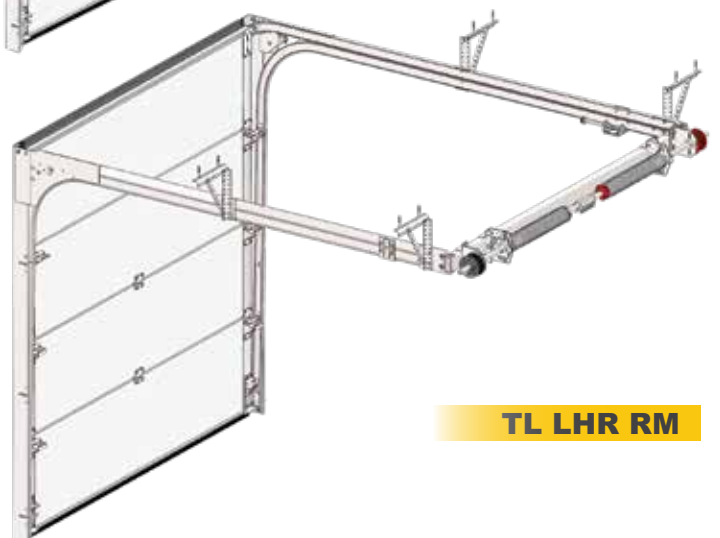

**TL LHR RM**

# Paneelid ja raamid



Vertikaalne fascia paneel



Horisontaalsed paneelid



ALU Lintel profiil.  
120 mm; 180 mm.



Alumiiniumist raamiprofiil  
85x40x40 mm



ALU raam (eesmine paigaldus)  
Lintel + post.  
Lintel 120 mm (suitable for LHR RM and R40).  
Lintel 180 mm (suitable for LHR FM).  
Posts 100 mm.



ALU raam vorminguga



# Lisatarvikud

Enamik meie uksi on elektriajamiga, kuid neile, mida kasutatakse manuaalselt, pakub Ryterna luku- ja käepideme komplekte.



UNIVERSAALNE LUKK



ÜMARA KÄEPIDEMEGA LUKK



ÜMAR KÄEPIDE



ROOSTEVABAST TERASEST LUKK



INTEGREERITUD POSTKAST



INTEGREERITUD POSTKAST



UNIVERSAALNE KÄEPIDE



RAL VÄRVITUD VENTILATSIOONIVÕRE



LEMMIKLOOMA UKS



Ukse riistvara (siinid, hinged, kronsteinid) saab pulbervärvida valge või peaaegu mistahes muu RAL kataloogis antud värvitooni.



# Sektsioon liuguks



RAL katalog

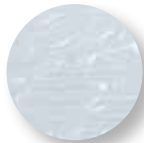

RAL 9016  
Puidusüü



RAL 9016  
Krohv



RAL 9016  
Sile

## Üksesektsioonide tüübid:



RIB



MIDRIB



FLUSH



SLICK

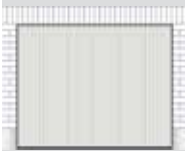

MICRORIB

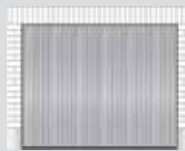

MACRORIB



CASSETTE



FV

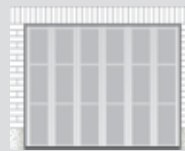

FV-filling

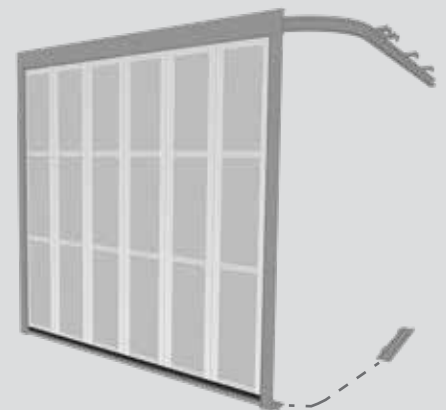



- Silmapaistev välimus koos täiusliku jõudluse ja vähese hooldusega.
- Palju disainivõimalusi – sh aknad, roostevaba metalli aplikatsioonid.
- Alumiiniumist riietvara saab sobiva pulbervärviga värvida, et see sobituks teie garaaži interjööri.

- Madala profiiliga lävepaku saab kinnitada otse olemasolevale garaažipõrandale.
- Harjaste tihendid kogu perimeetri ulatuses.
- Ühildub peaaegu kõigi elektrioperaatoritega.



# Siinitüüp SSD

Külgmine sektsioon-liuguks



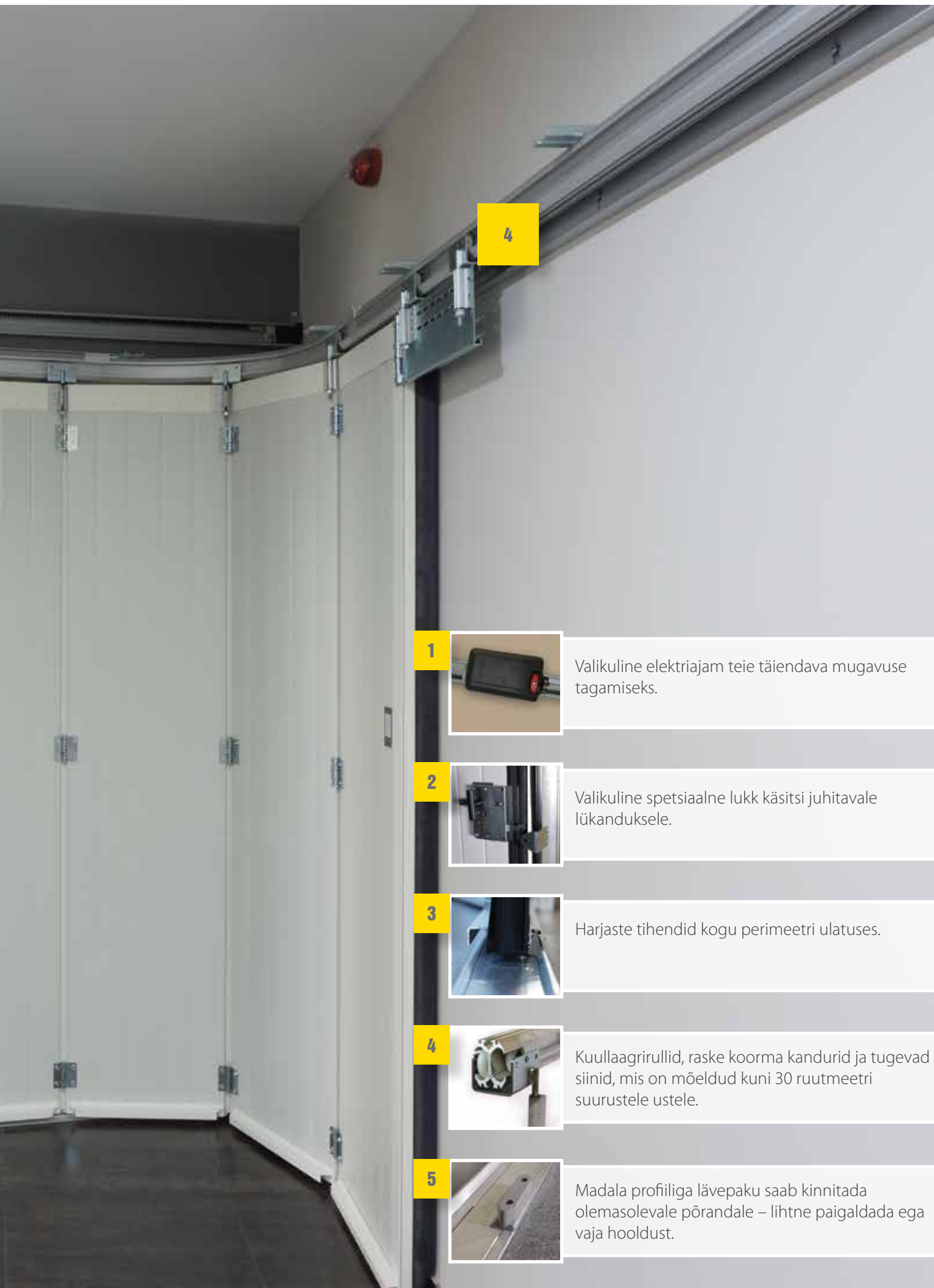

4

1



Valikuline elektriajam teie täiendava mugavuse tagamiseks.

2



Valikuline spetsiaalne lukk käsitsi juhitavale lükanduksele.

3



Harjaste tihendid kogu perimeetri ulatuses.

4



Kuullaagrirullid, raske koorma kandurid ja tugevad siinid, mis on mõeldud kuni 30 ruutmeetri suurustele ustele.

5



Madala profiiliga lävepaku saab kinnitada olemasolevale põrandale – lihtne paigaldada ega vaja hooldust.

## ERITELLIMUSEL VALMISTATUD UKSED



Garaažiuks ja fassaad on kaetud 50x50 mm lehispuitidega.



11 meetri laiune roheline vaskplekiga kaetud sektsioonuks.



Fassaadi tasapinnalised sektsioonuksed annavad võimaluse garaažiuksed ära peita.



Fassaadiga tasapinnaline garaažiuks, mis on kaetud tammelaudadega nagu maja fassaadi osa, saavutamaks 'varjatud' ukse efekt.

## MITTE-STANDARDSED LAHENDUSED



Garaažiuks on kaetud okoume ja kohandatud nikerdatud mustri- ja mustriga.



Okumega kaetud uks. Klaasitud paneel, millel on ristkaareline sisekujundus ja man nekeened, loomaks keskaegse pildi.



18 mm okoume vineerist vooder, mis on freesitud, loomaks konkreetse uksekujunduse vastavalt kaitseala eeskirjadele.



Kohandatud aplikatsioon ettevõtte logoga.



Roostevabast terasest aplikatsioonid vastavalt arhitekti kavandile.

## ÜHILDUVAD DISAINID





Kohandatud 'Moodsa' disainiga külghingedega uks.



Külghingedega garaažiuks on kaetud okoume vineeriga ja kohandatud suurusega akendega.



Külghingedega garaažiuks on kaetud 18 mm paksuse okoume vineeriga.



Külglükanduks kohandatud akende, post-kasti ja 80% läikega.



Side sliding door clad with okoume plywood.



Corten paneelidega plakeeritud külgmine lükanduks.



